

Finite state transducers

Data Structures and Algorithms for Computational Linguistics III
(ISCL-BA-07)

Çağrı Çöltekin

`ccoltekin@sfs.uni-tuebingen.de`

University of Tübingen
Seminar für Sprachwissenschaft

Winter Semester 2020/21

Finite state transducers

A quick introduction

- A *finite state transducer* (FST) is a finite state machine where transitions are conditioned on pairs of symbols
- The machine moves between the states based on an *input* symbol, while it outputs the corresponding *output* symbol
- An FST encodes a *relation*, a mapping from a set to another
- The relation defined by an FST is called a *regular* (or *rational*) relation

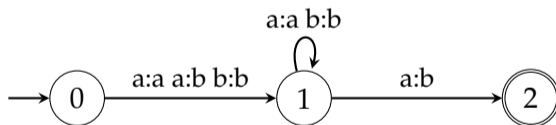

Finite state transducers

A quick introduction

- A *finite state transducer* (FST) is a finite state machine where transitions are conditioned on pairs of symbols
- The machine moves between the states based on an *input* symbol, while it outputs the corresponding *output* symbol
- An FST encodes a *relation*, a mapping from a set to another
- The relation defined by an FST is called a *regular* (or *rational*) relation

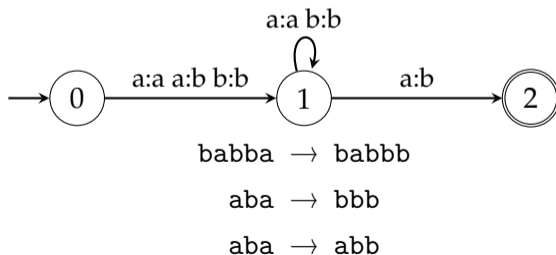

Formal definition

A finite state transducer is a tuple $(\Sigma_i, \Sigma_o, Q, q_0, F, \Delta)$

Σ_i is the *input* alphabet

Σ_o is the *output* alphabet

Q a finite set of states

q_0 is the start state, $q_0 \in Q$

F is the set of accepting states, $F \subseteq Q$

Δ is a relation $(\Delta : Q \times \Sigma_i \rightarrow Q \times \Sigma_o)$

Where do we use FSTs?

Uses in NLP/CL

- Morphological analysis
- Spelling correction
- Transliteration
- Speech recognition
- Grapheme-to-phoneme mapping
- Normalization
- Tokenization
- POS tagging (not typical, but done)
- partial parsing / chunking
- ...

Where do we use FSTs?

example 1: morphological analysis

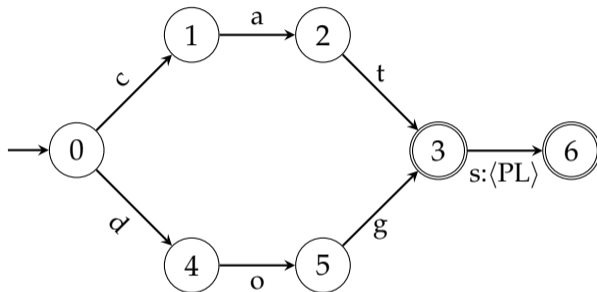

In this lecture, we treat an FSA as a simple FST that outputs its input:
the edge label 'a' is a shorthand for 'a:a'.

Where do we use FSTs?

example 2: POS tagging / shallow parsing

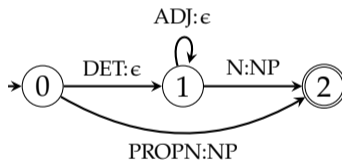
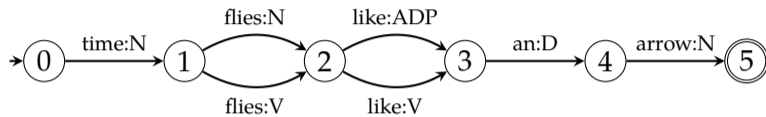

Note: (1) It is important to express the ambiguity. (2) This gets interesting if we can 'compose' these automata.

Closure properties of FSTs

Like FSA, FSTs are closed under some operations.

- Concatenation
- Kleene star
- Complement
- Reversal
- Union
- Intersection
- *Inversion*
- *Composition*

FST inversion

- Since an FST encodes a relation, it can be reversed
- Inverse of an FST swaps the input symbols with output symbols
- We indicate inverse of an FST M with M^{-1}

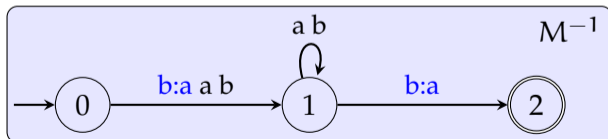
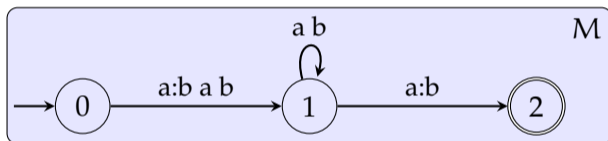

FST composition

sequential application

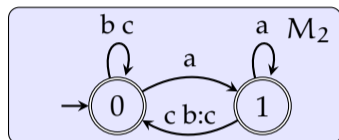
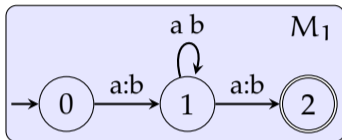

$$aa \xrightarrow{M_1} \rightarrow$$

$$bb \xrightarrow{M_1} \rightarrow$$

$$aaaa \xrightarrow{M_1} \rightarrow$$

$$abaa \xrightarrow{M_1} \rightarrow$$

FST composition

sequential application

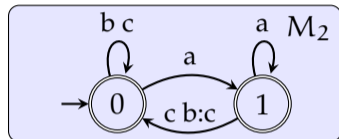
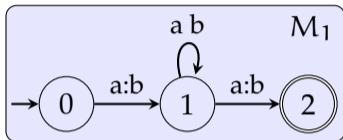

aa	$\xrightarrow{M_1}$	bb	$\xrightarrow{M_2}$
bb	$\xrightarrow{M_1}$	\emptyset	$\xrightarrow{M_2}$
$aaaa$	$\xrightarrow{M_1}$	$baab$	$\xrightarrow{M_2}$
$abaa$	$\xrightarrow{M_1}$	$bbab$	$\xrightarrow{M_2}$

FST composition

sequential application

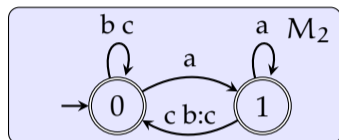
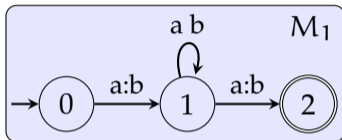

	$M_1 \circ M_2$			
	→			
aa	$\xrightarrow{M_1}$	bb	$\xrightarrow{M_2}$	bb
bb	$\xrightarrow{M_1}$	\emptyset	$\xrightarrow{M_2}$	\emptyset
aaaa	$\xrightarrow{M_1}$	baab	$\xrightarrow{M_2}$	baac
abaa	$\xrightarrow{M_1}$	bbab	$\xrightarrow{M_2}$	bbac

- Can we compose two FSTs without running them sequentially?

FST composition

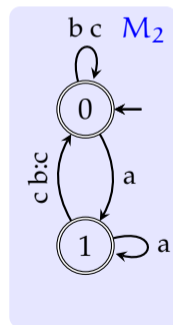
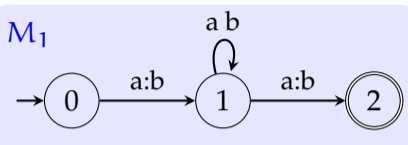

FST composition

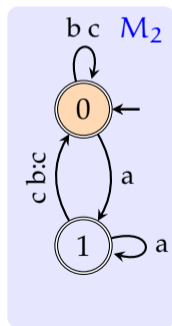
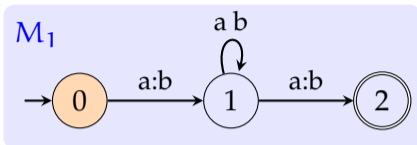

FST composition

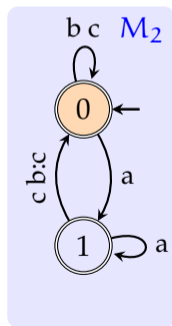
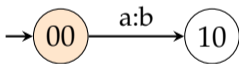
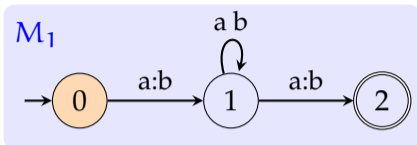

FST composition

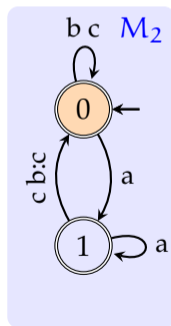
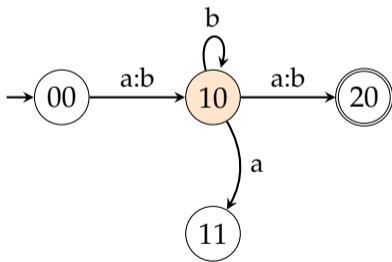
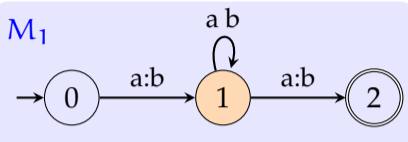

FST composition

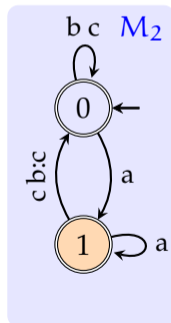
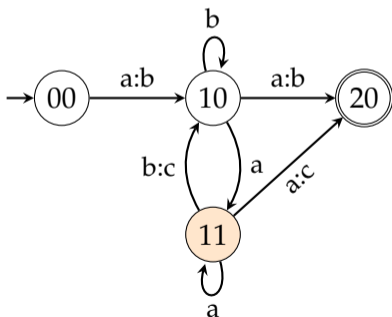
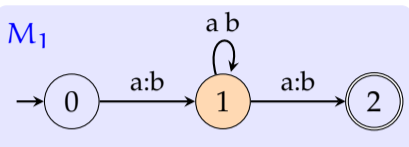

FST composition

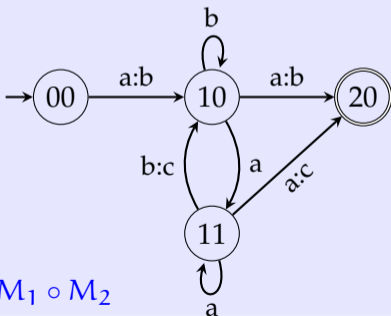
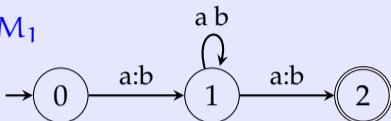
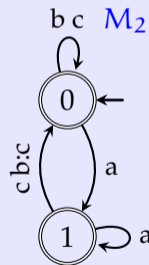
 M_1

 $M_1 \circ M_2$

 M_2

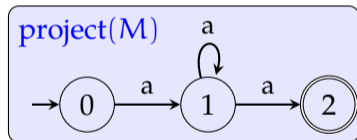
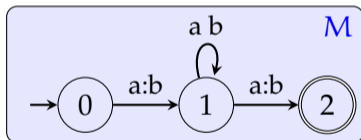
Projection

- *Projection* turns an FST into a FSA, accepting either the input language or the output language



FST determinization

- A deterministic FST has unambiguous transitions from every state on any *input* symbol
- We can extend the subset construction to FSTs
- Determinization of FSTs means converting to a *subsequential* FST
- However, not all FSTs can be determinized

FST determinization

- A deterministic FST has unambiguous transitions from every state on any *input* symbol
- We can extend the subset construction to FSTs
- Determinization of FSTs means converting to a *subsequential* FST
- However, not all FSTs can be determinized

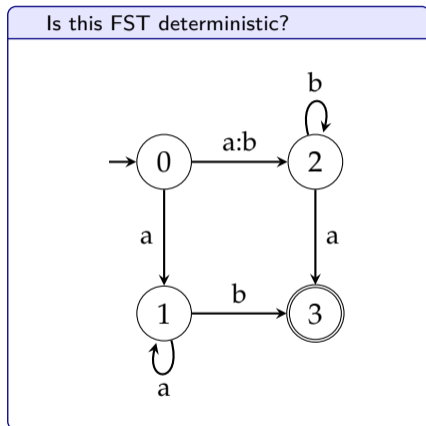

Sequential FSTs

- A sequential FST has a single transition from each state on every *input* symbol
- Output symbols can be strings, as well as ϵ
- The recognition is linear in the length of input
- However, sequential FSTs do not allow ambiguity

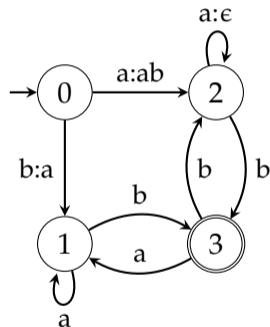

Subsequential FSTs

- A *k*-subsequential FST is a sequential FST which can output up to *k* strings at an accepting state
- Subsequential transducers allow limited ambiguity
- Recognition time is still linear

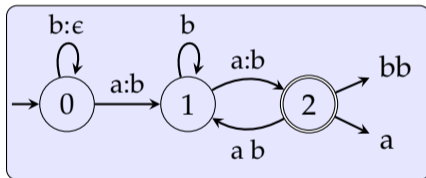

- The 2-subsequential FST above maps every string it accepts to two strings, e.g.,
 - $baa \rightarrow bba$
 - $baa \rightarrow bbbb$

An exercise

Convert the following FST to a subsequential FST

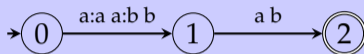

An exercise

Convert the following FST to a subsequential FST

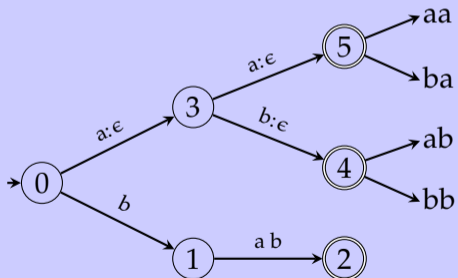

Determinizing FSTs

Another example

Can you convert the following FST to a subsequential FST?

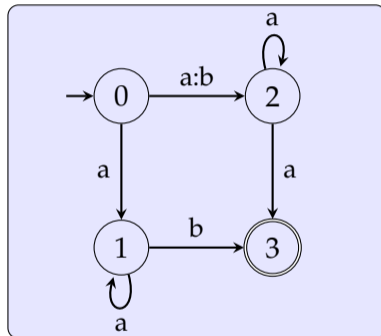

Determinizing FSTs

Another example

Can you convert the following FST to a subsequential FST?

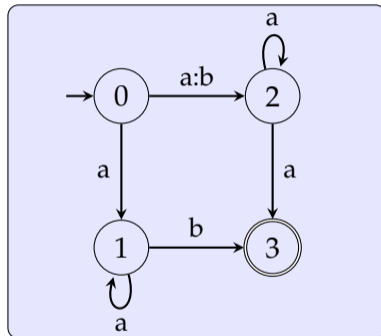

Note that we cannot 'determine' the output on first input, until reaching the final input.





FSA vs FST

- FSA are *acceptors*, FSTs are *transducers*
- FSA accept or reject their input, FSTs produce output(s) for the inputs they accept
- FSA define sets, FSTs define relations between sets
- FSTs share many properties of FSAs. However,
 - FSTs are not closed under intersection and complement
 - We can compose (and invert) the FSTs
 - Determinizing FSTs is not always possible
- Both FSA and FSTs can be weighted (not covered in this course)

References / additional reading material

- Jurafsky and Martin (2009, Ch. 3)
- Additional references include:
 - Roche and Schabes (1996) and Roche and Schabes (1997): FSTs and their use in NLP
 - Mohri (2009): weighted FSTs

References / additional reading material (cont.)

-  Jurafsky, Daniel and James H. Martin (2009). *Speech and Language Processing: An Introduction to Natural Language Processing, Computational Linguistics, and Speech Recognition*. second edition. Pearson Prentice Hall. ISBN: 978-0-13-504196-3.
-  Mohri, Mehryar (2009). “Weighted automata algorithms”. In: *Handbook of Weighted Automata*. Monographs in Theoretical Computer Science. Springer, pp. 213–254.
-  Roche, Emmanuel and Yves Schabes (1996). *Introduction to Finite-State Devices in Natural Language Processing Technical Report*. Tech. rep. TR96-13. Mitsubishi Electric Research Laboratories. URL:
<http://www.merl.com/publications/docs/TR96-13.pdf>.
-  — (1997). *Finite-state Language Processing*. A Bradford book. MIT Press. ISBN: 9780262181822.

